



DE VALK
YACHT BROKERS



DEHLER 41 DS



DE VALK
YACHT BROKERS

DEHLER 41 DS

VAN DE MAKELAAR

The Dehler 41DS is a comfortable, fast and safe full weather cruisingyacht. As known from Dehler every design is well thought through and innovative. Resulting in an extremely easy to handle sailingyacht. With incorporated decksaloon with a generous U-shaped sofa and panoramic view.

Marc Weijenberg

SPECIFICATIES

| | | | |
|-------------------|-------------------------|----------------------|------------------------|
| Afmetingen | 12.45 x 3.90 x 1.95 (m) | Bouwer | Dehler Yachtbau |
| Bouwjaar | 1999 | Hutten | 2 |
| Materiaal | Polyester | Slaapplaatsen | 6 |
| Motor(en) | 1 x Yanmar 4JH3E Diesel | Pk/Kw | 56.00 (pk), 41.16 (kw) |
| Vraagprijs | verkocht (BTW) | Ligplaats | bij verkoopkantoor |

CONTACT

| | | | |
|----------------|---|-----------------|------------------------|
| Kantoor | De Valk Sint Annaland | Telefoon | +31 166 601 000 |
| Adres | Koelhuisweg 4 4697 RM Sint Annaland The Netherlands | E-mail | sintannaland@devalk.nl |

DISCLAIMER

Hoewel er uiterste zorg besteed is aan de correctheid, volledigheid en actualiteit van onze informatie kunnen hieraan geen rechten worden ontleend.



ALGEMEEN

| | |
|-----------------------|------------------------|
| Model | DEHLER 41 DS |
| Type | zeiljacht |
| Lengte (m) | 12,45 |
| Lengte waterlijn (m) | 11,05 |
| Breedte (m) | 3,90 |
| Diepgang (m) | 1,95 |
| Doorvaarhoogte (m) | 19,50 |
| Stahoogte (m) | 1,95 |
| Bouwjaar | 1999 |
| Te waterlating | 2001 |
| Gebouwd door | Dehler Yachtbau |
| Land | Duitsland |
| Ontwerper | Judel & Vrolijk |
| Waterverplaatsing (t) | 8,3 |
| Ballast (ton) | gietijzer met lood 3,3 |
| CE norm | A |
| Romp materiaal | polyester |
| Romp kleur | blauw |
| Rompvorm | rondspant |
| Kiel type | vin kiel |
| Materiaal opbouw | polyester |
| Stootlijst | rubber |
| Dek materiaal | polyester |
| Afwerking dek | teak |
| Afwerking opbouw | verf |
| Afwerking kuip | teak |
| Raamlijsten | aluminium |
| Raammateriaal | perspex |
| Dekluik | ja |
| Patrijspooten | aluminium |



| | |
|------------------------|-------------------------------|
| Brandstoftank (liter) | roestvast staal 160 |
| Drinkwatertank (liter) | kunststof 400 |
| Vuilwatertank (liter) | roestvast staal 50 |
| Vuilwatertank afvoer | dekafzuigpunt + pomp |
| Stuurwiel | kabelbesturing Whitlock |
| Noodhelmstok | ja |
| Extra info | Romp moet geschilderd worden. |

ACCOMMODATIE

| | |
|----------------------|---------------------------------------|
| Hutten | 2 |
| Slaapplaatsen | 6 |
| Interieur | kersen |
| Vloer | houtprint |
| Deksalon | ja |
| Stahoogte salon (m) | 1,90 |
| Verwarming | diesel hete lucht Webasto Airtop 5000 |
| Kaartentafel | ja |
| Achterkajuit | ja |
| Dinette om te bouwen | ja |
| Keuken | ja |
| Aanrechtblad | kunststof |
| Spoelbak | roestvast staal 2x |
| Kooktoestel | gas Triton 3burner |
| Oven | Triton |
| Koelkast | Coolmatic 12V |
| Warmwatersysteem | 220V + motor |
| Waterdruksysteem | elektrisch |
| Eigenaarshut | tweepersoonsbed |
| Lengte bed (m) | 2,05 x 1,50 |
| Kledingkast | hangend/lades/legplanken |
| Badkamer | en suite I |



| | |
|----------------|---|
| Toilet | en suite |
| Toilet Systeem | handbediening |
| Wasbak | in de badkamer |
| Douche | en suite |
| Gastenhut 1 | tweepersoonsbed |
| Lengte bed (m) | 1,98 x 1,70 |
| Kledingkast | hangend/lades/legplanken |
| Extra info | De opvallend comfortabele decksalon geeft u een panoramisch uitzicht. |

MOTOR(EN)

| | |
|------------------------|---------------------------|
| Aantal motoren | 1 |
| Merk | Yanmar |
| Type | 4JH3E |
| Pk | 56,00 |
| kW | 41,16 |
| Brandstof | diesel |
| Geïnstalleerd in jaar | 1999 |
| Maximale snelheid (kn) | 7 |
| Kruissnelheid (kn) | 6,5 |
| Verbruik (ltr/uur) | 2,5 |
| Motoruren | 1330 |
| Koelsysteem motor | indirecte warmtewisselaar |
| Aandrijving | schroefas |
| Motorbediening | bowden kabels |
| Keerkoppeling | mechanisch |
| Boegschroef | elektrisch Vetus 50kgf |
| Uitlaatsysteem | watergekoeld |
| Type schroef | vaanstand Vari-Prop |
| Schroefbladen | 3 |
| Materiaal schroefas | roestvast staal |



| | |
|-------------------------|---------------------------|
| Smering schroefas | water |
| Handlenspomp | ja |
| Elektrische lenspomp | ja |
| Elektrische installatie | 12/220V |
| Startaccu | 1 x 63amp |
| Lichtaccu | 2 x 210 amp |
| Boegschroefaccu | ja |
| Accu monitor | ja |
| Acculader | Mastervolt Smart 12v-40ah |
| Walstroom | met kabel |

NAVIGATIE

| | |
|-------------------------|---------------------------------|
| Kompas | moet geserviced worden Suunto |
| Electrisch kompas | via autopiloot |
| Dieptemeter | Raymarine ST60 |
| Log | Raymarine ST60 |
| Windmeetset | Raymarine ST60 |
| Repeaters | bij kaartentafel Raymarine ST60 |
| Marifoon | Icom IC-M411 |
| Autopiloot | Raymarine ST6000+ |
| Roerstand aanwijzer | via autopiloot |
| GPS | Garmin 128 |
| Plotter | Raytheon A50 |
| Navtex | Nasa |
| Elektronische kaart(en) | geen elektr kaartje |
| Navigatieverlichting | ja |

UITRUSTING

| | |
|-------------|----|
| Vaste ramen | ja |
| Buiskap | ja |
| Kuipent | ja |



| | |
|-----------------------------|-------------------|
| Kuipkussens | ja |
| Kuiptafel | ja |
| Zwemplatform | ja |
| Zwemtrap | roestvast staal |
| Boegtrap | ja |
| Anker | ja |
| Ankerketting | ja |
| Ankerlier | elektrisch Lewmar |
| Zeereling | draad |
| Zij-instap in reling | ja |
| Hekstoel | ja |
| Preekstoel | ja |
| Reddingsvlot | container Seatec |
| Reddingsvlot (pers) | 4 |
| Reddingsvlot laatst gekeurd | 04-2019 |
| Trossensnijder | ja |
| Stootkussens | ja |
| Landvasten | ja |
| Radio-cd speler | ja |
| Kuipspeakers | ja |
| Speakers in salon | ja |
| Klok - barometer | ja |

TUIGAGE

| | |
|---------------------|------------------------|
| Tuigage | fractioneel |
| Staad want | draad |
| Merk mast | Sparcraft |
| Materiaal mast | aluminium |
| Zalingen | 2 sets |
| Grootzeilhuik | Dehler Maindrop System |
| Doorgelat grootzeil | Elvstrom |



| | |
|-------------------------------------|-------------------------------|
| Fok | zelf-kerend Elvstrom (1999) |
| Fok I | zelf-kerend Elvstrom (2003) |
| Genua rolreefsysteem | Furlex 300S |
| Genua hoes | ja |
| Gennaker | met opbergslurf Elvstrom |
| Zelf kerende fok installatie | ja |
| Reefinstallatie | snel-één-lijn reefstelsysteem |
| Achterstagspanner | talie |
| Giekneerhouder | talie Easy-Kick II |
| Primaire schootlieren | elektrisch 2 x Harken 44 EST |
| Multifunctionele lieren | 1x Lewmar 30AST |
| Spinnakerboom | aluminium |



DEHLER 41 DS



DEHLER 41 DS



DEHLER 41 DS

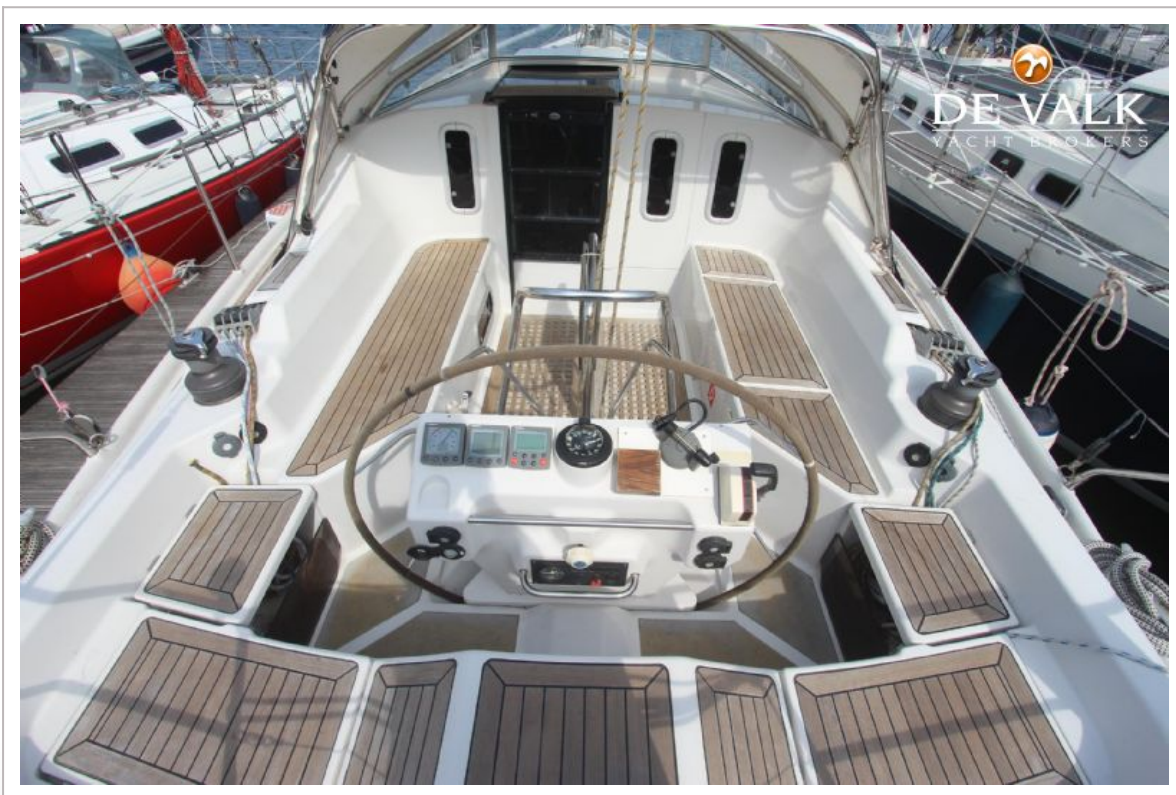

DEHLER 41 DS

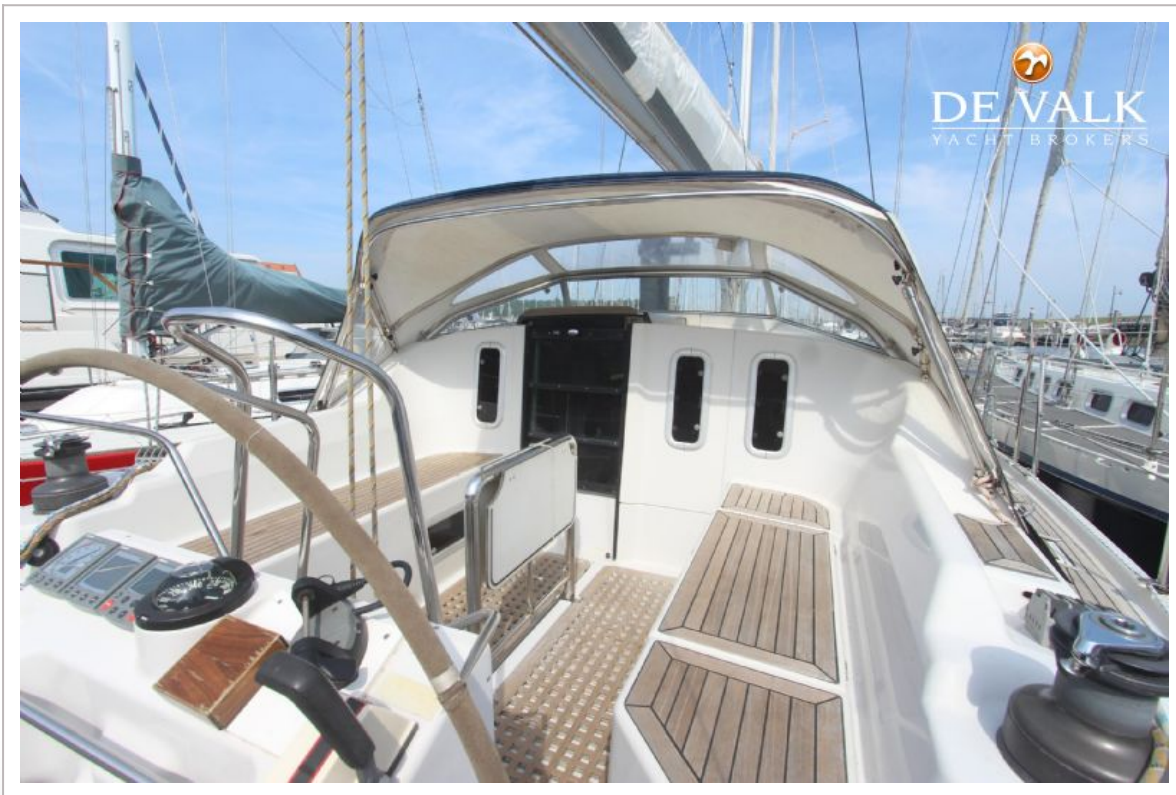

DEHLER 41 DS



DEHLER 41 DS

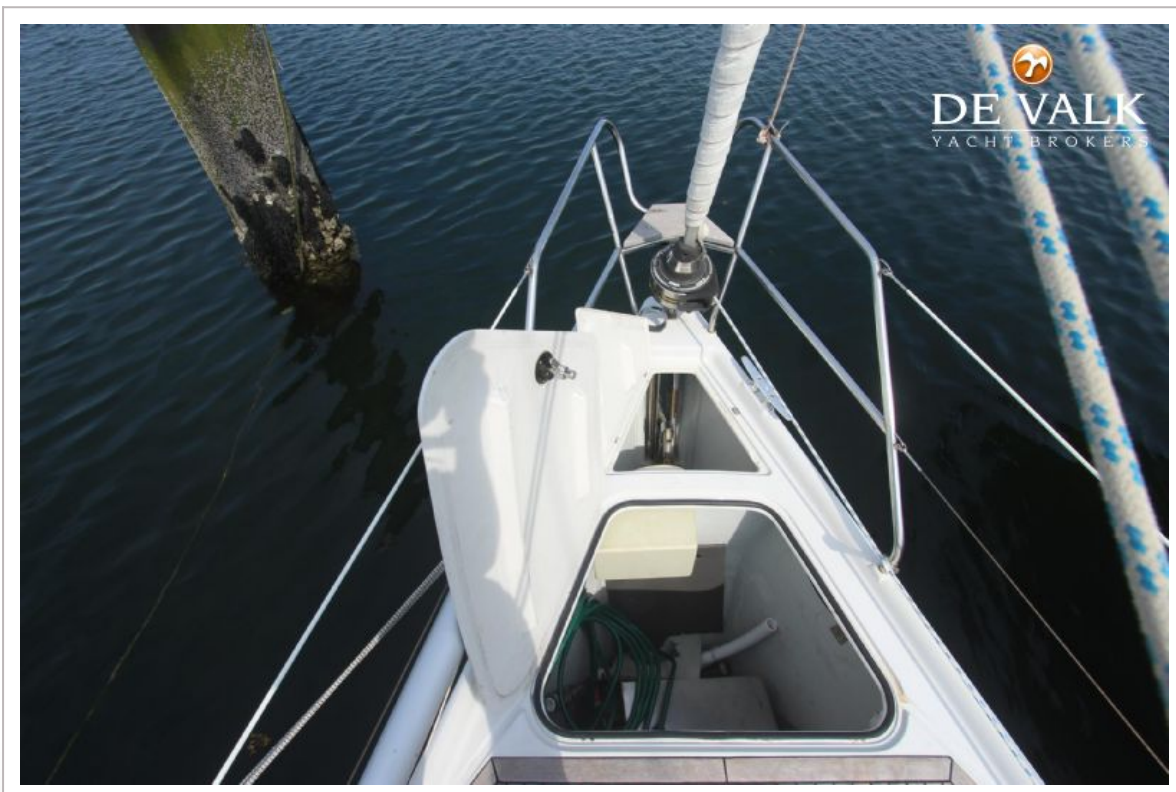

DEHLER 41 DS



DEHLER 41 DS



DEHLER 41 DS



DEHLER 41 DS



DEHLER 41 DS

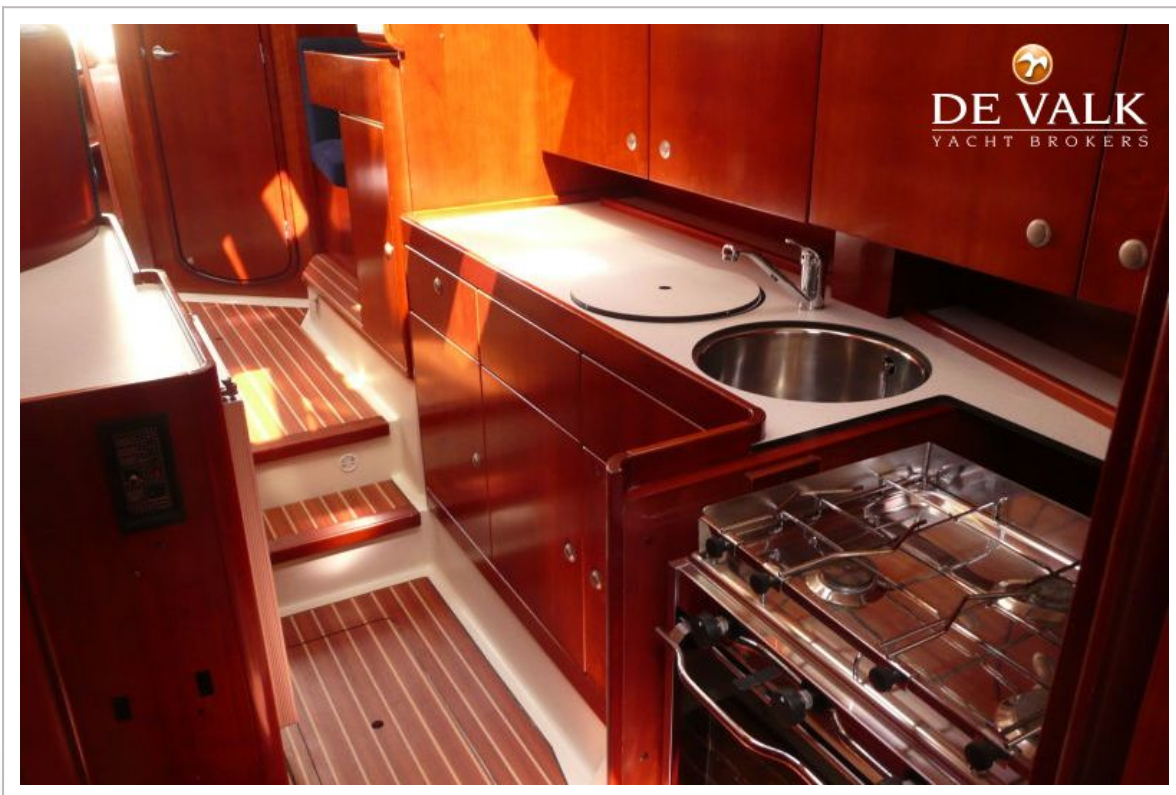

DEHLER 41 DS

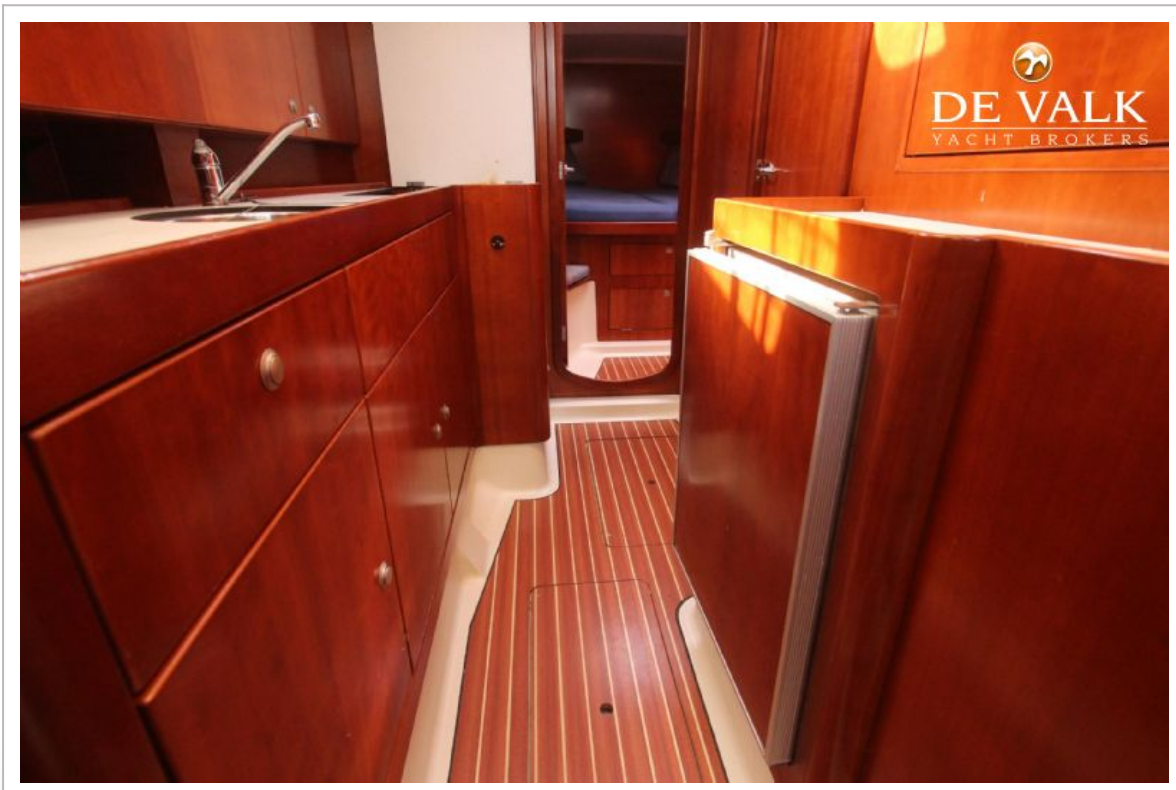

DEHLER 41 DS



DEHLER 41 DS

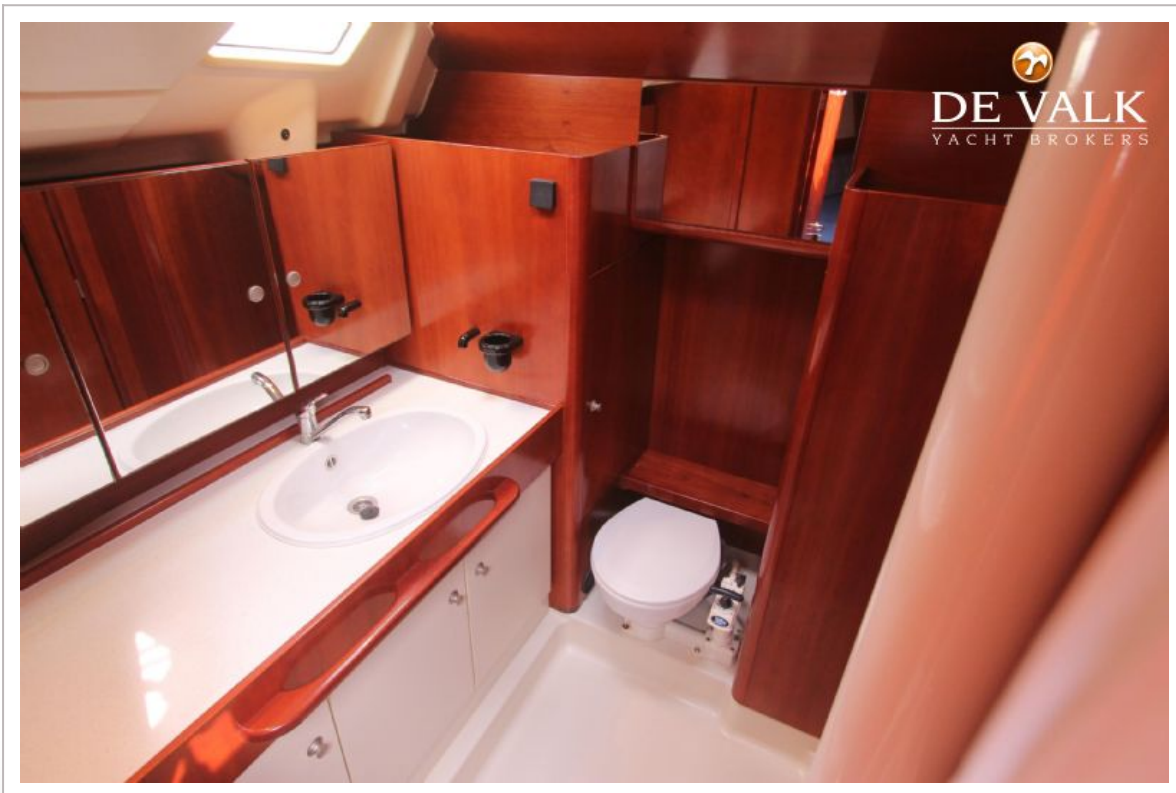

DEHLER 41 DS

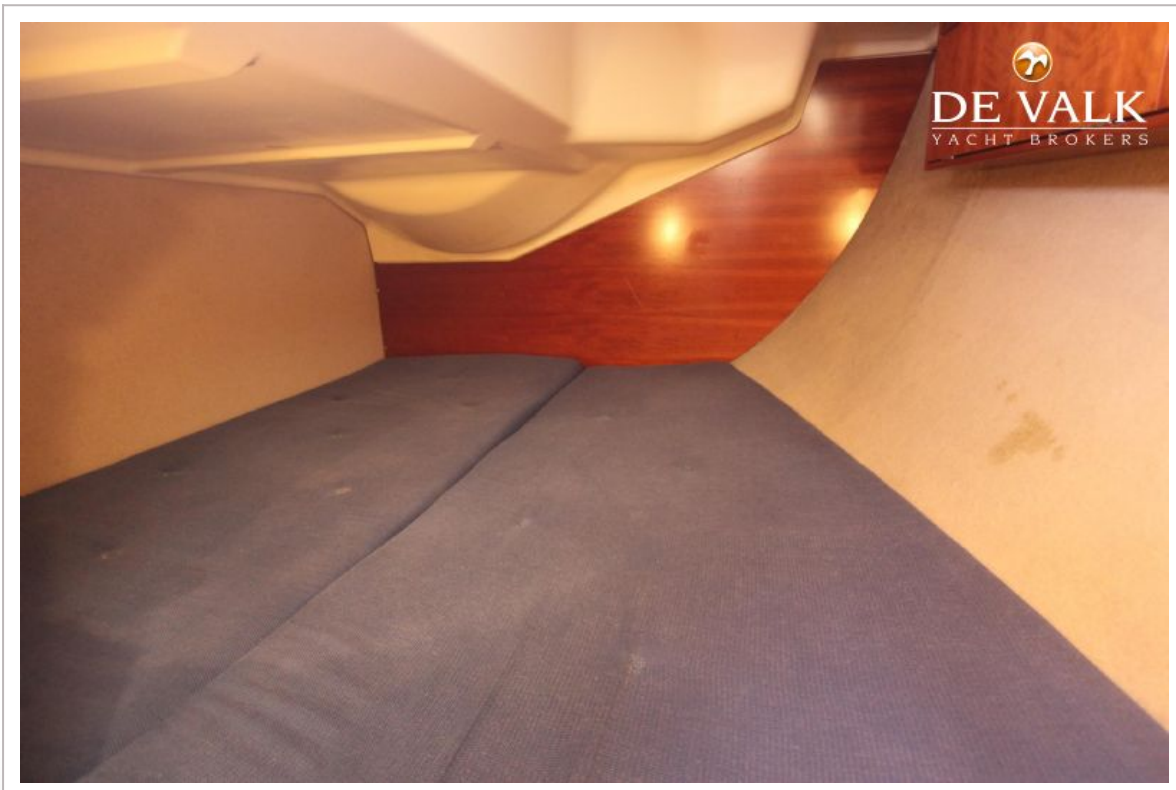

DEHLER 41 DS

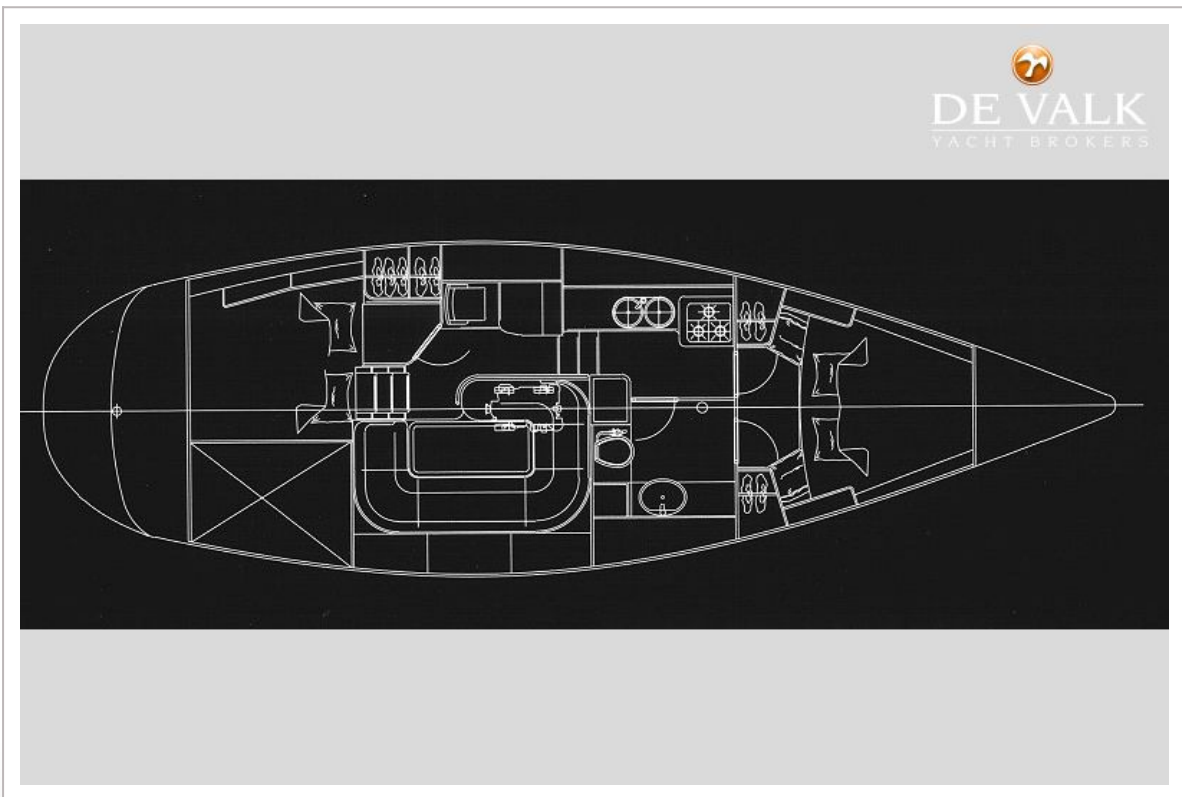

DEHLER 41 DS



DEHLER 41 DS

